



Lumitech Lighting Solution GmbH | Technologiepark 10 | 8380 Jennersdorf | Austria

www.lumitech.com

		LUMITECH YOUR LIGHTING SOLUTION	
9 010315 128772		TYPE LED LE2013 NW 14L14-2 24V/100mA IP67 E NB-ASY	
CODE	91461011	Number of LED modules	
BATCH	123456		
QTY	1 pcs	CoO: European Union	

Maximum number of LED modules for daisy-chaining at driving current 80mA = 65 (in total for all luminaires)

Maximum number of LED modules for daisy-chaining at driving current 120mA = 45 (in total for all luminaires)

CONSTANT VOLTAGE
24V DC SELV
USE ONLY 24V DC DRIVER!

RECOMMENDED CONNECTION

TECHNICAL STANDARDS

- | | |
|--------------|----------|
| EN 60598-1 | EN 62471 |
| EN 60598-2-1 | EN 55015 |
| EN 62031 | EN 61547 |

IP67

230V

+55°C
-30°C

MOUNTING POSSIBILITIES

Mounting Clip

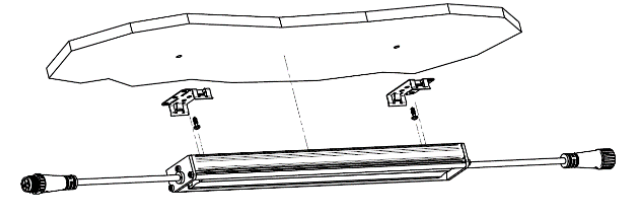
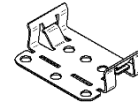

Screw channel - M3

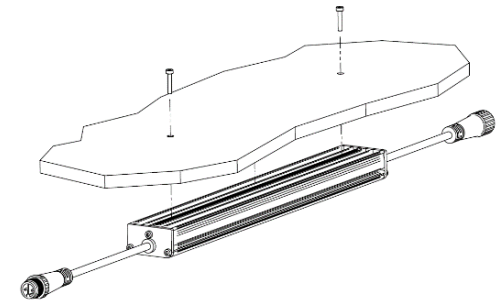
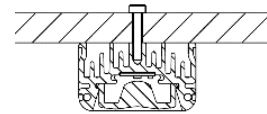

Assembly Bracket – Orientation 90°

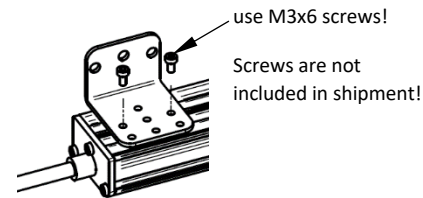

Orientation of Wall washer lens

Male connector on this side

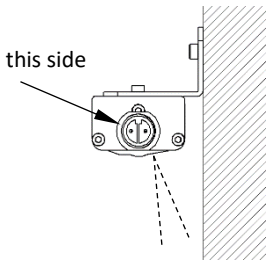

Assembly Bracket – Orientation 0°

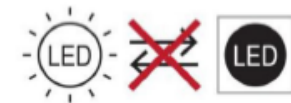
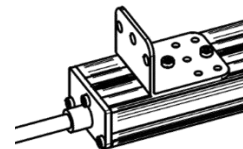

Non-replaceable, light source