

## CANOPY | Sense Line



Refrigeration & Freezer equipment



Canopy lighting



High efficiency



QCS  
Quick-Connection-System



Dimmable



Various lengths

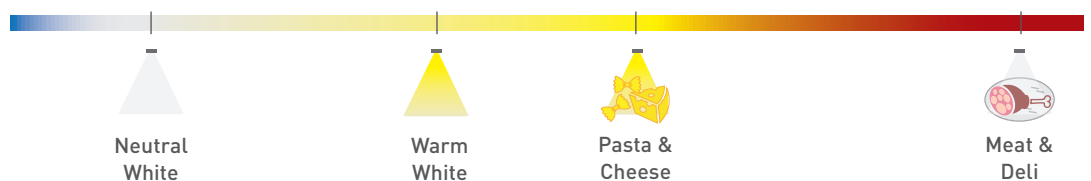

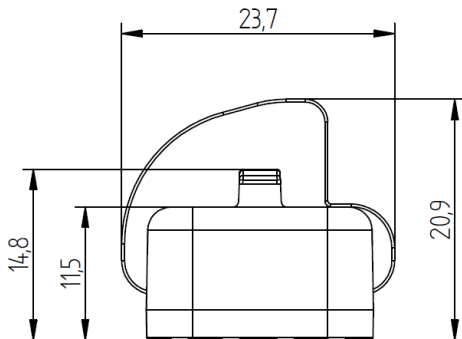

### PRODUCT DESCRIPTION

- High efficient canopy lighting for cooling and freezer cabinets
- Available in a variety of light colours and can be matched to specific food types
- Ready-to-connect solution available, thanks to our Quick Connection System (QCS)
- High operational performance due to directional lighting, integrated heat removal and highly efficient LEDs
- Excellent product illumination thanks to the combination of SMD LEDs and innovative optics
- Avoids glare and reflections
- Safe-use operation due safety extra-low voltage (SELV)
- Simple installation with application of fixing plates
- Heat sink profile made of anodised, extruded aluminium
- LED modules protected against moisture & dust by Conformal coating
- End caps made of PBT
- Linear lenses made of PMMA
- Dimming capability

### TECHNICAL DATA

Supply voltage	24 VDC
Ambient temperature $t_a$	-30 ... +30 °C
Max. surface temperature on profile $t_c$	60 °C
Type of protection	IP20
Protection class	III
Risk group (EN 62471:2008)	1

IP20

### ENERGY CLASS

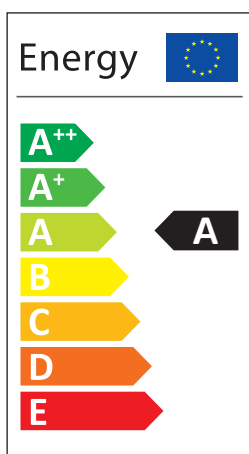

### APPLICATION

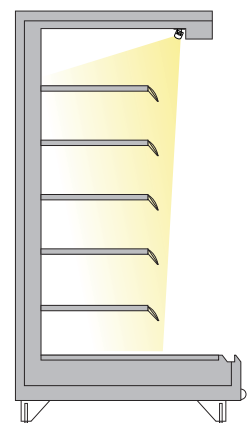

## CANOPY | Sense Line

### TECHNICAL DATA | ORDER DATA

Art. Nr.	Type	Colour	No. of modules	Luminous flux (lm)	Power (W)	CRI
91440000	Sense-Line Canopy 910mm, 4000K CRI90, 12W, CLW8QY	Neutral White	6	1240	11,4	≥90
91440001	Sense-Line Canopy 910mm, 3000K CRI90, 12W, CLW8QY	Warm White	6	1080	11,4	≥90
91440002	Sense-Line Canopy 910mm, 2700K CRI90, 12W, CLW8QY	Pasta & Cheese	6	1030	11,4	≥90
91440003	Sense-Line Canopy 910mm, Meat CRI90, 12W, CLW8QY	Meat & Deli	6	970	11,4	≥90
91440004	Sense-Line Canopy 910mm, 4000K CRI90, 15W, HO, CLW8QY	Neutral White	6	1550	15,0	≥90
91440005	Sense-Line Canopy 910mm, 3000K CRI90, 15W, HO, CLW8QY	Warm White	6	1350	15,0	≥90
91440006	Sense-Line Canopy 910mm, 2700K CRI90, 15W, HO, CLW8QY	Pasta & Cheese	6	1280	15,0	≥90
91440007	Sense-Line Canopy 910mm, Meat CRI90, 15W, HO, CLW8QY	Meat & Deli	6	1210	15,0	≥90
91440008	Sense-Line Canopy 1200mm, 4000K CRI90, 16W, CLW8QY	Neutral White	8	1660	15,2	≥90
91440009	Sense-Line Canopy 1200mm, 3000K CRI90, 16W, CLW8QY	Warm White	8	1440	15,2	≥90
91440010	Sense-Line Canopy 1200mm, 2700K CRI90, 16W, CLW8QY	Pasta & Cheese	8	1370	15,2	≥90
91440011	Sense-Line Canopy 1200mm, Meat CRI90, 16W, CLW8QY	Meat & Deli	8	1300	15,2	≥90
91440012	Sense-Line Canopy 1200mm, 4000K CRI90, 20W, HO, CLW8QY	Neutral White	8	2070	20,0	≥90
91440013	Sense-Line Canopy 1200mm, 3000K CRI90, 20W, HO, CLW8QY	Warm White	8	1800	20,0	≥90
91440014	Sense-Line Canopy 1200mm, 2700K CRI90, 20W, HO, CLW8QY	Pasta & Cheese	8	1710	20,0	≥90
91440015	Sense-Line Canopy 1200mm, Meat CRI90, 20W, HO, CLW8QY	Meat & Deli	8	1620	20,0	≥90
91440016	Sense-Line Canopy 1760mm, 4000K CRI90, 23W, CLW8QY	Neutral White	12	2480	22,8	≥90
91440017	Sense-Line Canopy 1760mm, 3000K CRI90, 23W, CLW8QY	Warm White	12	2160	22,8	≥90
91440018	Sense-Line Canopy 1760mm, 2700K CRI90, 23W, CLW8QY	Pasta & Cheese	12	2050	22,8	≥90
91440019	Sense-Line Canopy 1760mm, Meat CRI90, 23W, CLW8QY	Meat & Deli	12	1940	22,8	≥90
91440020	Sense-Line Canopy 1760mm, 4000K CRI90, 30W, HO, CLW8QY	Neutral White	12	3100	30,0	≥90
91440021	Sense-Line Canopy 1760mm, 3000K CRI90, 30W, HO, CLW8QY	Warm White	12	2690	30,0	≥90
91440022	Sense-Line Canopy 1760mm, 2700K CRI90, 30W, HO, CLW8QY	Pasta & Cheese	12	2560	30,0	≥90
91440023	Sense-Line Canopy 1760mm, Meat CRI90, 30W, HO, CLW8QY	Meat & Deli	12	2420	30,0	≥90

Packaging: 12 pieces/carton, 360 pieces/pallet

- All typical values for Ta=25°C +/- 2°C, setting time =200ms
- Luminous flux min. value = typ. value - 20%
- Tolerance mechanical dimensions +/- 1mm
- Tolerance electrical data +/- 15%
- Tolerance optical data +/-10%

### CONVERTER

Output voltage	24 VDC +10 %
Power converter	= sum of the typical individual power of the light engines + 20%
Chain length (luminaires)	120mA: max 21 modules 100mA: max 24 modules 80mA: max 28 modules 60mA: max 33 modules 40mA: max 40 modules

#### Selection of the operating device/protective functions

The operating device protects the modules against overvoltage, overcurrent, overload and short circuits. The device must comply with the relevant standards for safe operation in freezer and refrigeration equipment. Power supply units must ensure the following protective measures:

- SELV
- Short-circuit protection
- Overload protection
- Overtemperature protection
- Protection against environmental influences

## CANOPY | Sense Line

### ACCESSORY - MOUNT | FIXING PLATES

Type	METAL 0°	METAL 0° magnetic	METAL 30°	METAL 45°	METAL adjustable	METAL adjustable magnetic
Art. Nr.	88167376	88167382	88167378	88167379	88167384	88167385



### QUICK-CONNECTION-SYSTEM (QCS) | BRIDGES

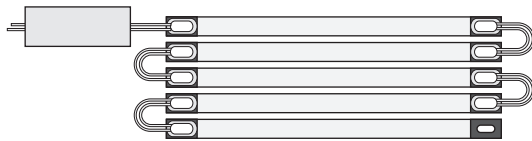

- Bridge for connecting two linear LED engines via QCS
- Bridge for connecting a linear LED engine to a feeder link via QCS

#### ORDER DATA - Bridges

Length	Weight	Type	Art. Nr.
30 mm	0.004 kg	LED Bridge QCS 30 **	89601262
50 mm	0.004 kg	LED Bridge QCS 50 **	89601263
100 mm	0.005 kg	LED Bridge QCS 100 **	89601264
250 mm	0.007 kg	LED Bridge QCS 250 **	89601265
400 mm	0.009 kg	LED Bridge QCS 400 **	89601266
800 mm	0.016 kg	LED Bridge QCS 800 **	89601267
1,200 mm	0.022 kg	LED Bridge QCS 1200 *	89601268
2,000 mm	0.034 kg	LED Bridge QCS 2000 *	89601269

Packaging: \* 25 pieces/carton, 400 pieces/pallet | \*\* 50 pieces/carton, 800 pieces/pallet  
Also available in black.

RoHS

### QUICK-CONNECTION-SYSTEM (QCS) | FEEDER CABLE



- Feeder cable for connecting a linear LED engine to a converter via QCS

#### ORDER DATA - Feeder Cable

Length	Weight	Type	Art. Nr.
500 mm	0.009 kg	LED Feeder QCS 500 **	89601258
1,000 mm	0.017 kg	LED Feeder QCS 1000 **	89601259
1,500 mm	0.025 kg	LED Feeder QCS 1500 *	89601260
2,000 mm	0.033 kg	LED Feeder QCS 2000 *	89601261
4,000 mm	0.065 kg	LED Feeder QCS 4000 ***	89601601

Packaging: \* 25 pieces/carton, 400 pieces/pallet | \*\* 50 pieces/carton, 800 pieces/pallet | \*\*\* 10 pieces/carton  
Also available in black.

RoHS

## CANOPY | Sense Line

### III QUICK-CONNECTION-SYSTEM (QCS) | FEEDER LINK

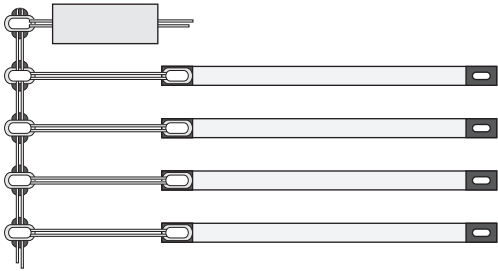
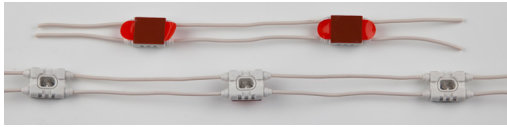

- Flexible feeder link for connecting several linear LED engines to a converter
- Slots equipped with double-sided adhesive tape

#### III ORDER DATA - Feeder Link

Length	Spacing	Type	Art. Nr.
10m	108 mm	LED Feeder Link QCS	88711762

Packaging: 1 roll corresponds to 10m with 92 slots

RoHS

### III QCS | MULTIPLE CONNECTOR LINE QCS

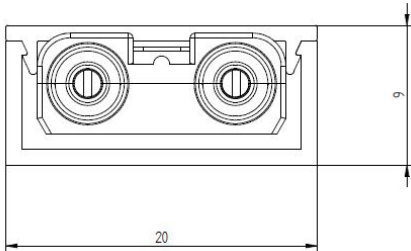

- Multiple Connector Line for connecting several linear LED engines to a converter

#### III ORDERING DATA - Multiple Connector Line QCS

Length	Spacing	Type	Art. Nr.
1,0m	10cm	MULTIPLE CONNECTOR LINE QCS white 1,0m (10 plugs)	88167422

Packaging: 2 pieces/carton, 24 pieces/outer carton

RoHS

### III QCS | PROTECTION SET



- Cover to protect QCS connectors

#### III ORDERING DATA - Protection Set

Type	Packaging	Art. Nr.
LED PROTECTION QCS BLIND CAP	1 bag (holds 100 pieces)	88167414
LED PROTECTION QCS END CAP	1 bag (holds 50 pieces)	88167415

RoHS

## CANOPY | Sense Line

### COORDINATES AND TOLERANCES ACCORDING TO CIE 1964 - DATA REFERS ONLY TO LED MODULES WITHOUT COVER

#### Neutral White



**CIE coordinates**  
**Neutral White 4100K**

	x0	y0
Centre	0.3770	0.3660

MacAdam Ellipse: 3SDCM

Suitable, e.g., for dairy products and frozen products

#### Pasta & Cheese

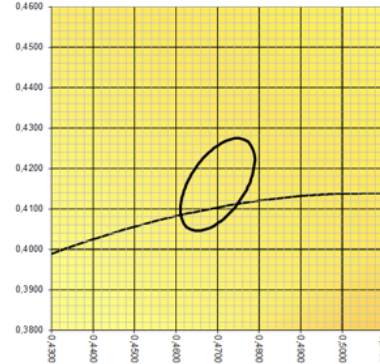

**CIE coordinates**  
**Pasta & Cheese 2600K**

	x0	y0
Centre	0.4750	0.4160

MacAdam Ellipse: 3SDCM

Special colour for pasta & cheese

#### Warm White



**CIE coordinates**  
**Warm White 2800K**

	x0	y0
Centre	0.4480	0.3990

MacAdam Ellipse: 3SDCM

Suitable, e.g., for vegetables, fruit and wine

#### Meat & Deli

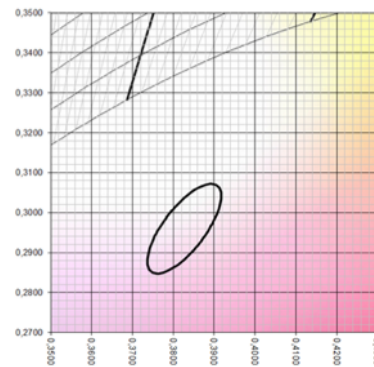

**CIE coordinates**  
**Meat & Deli**

	x0	y0
Centre	0.3830	0.3060

MacAdam Ellipse: 3SDCM

Special colour for meat and deli

### COLOUR KEY

Code	CW	NW	WW	PC	BP	PM
Colour	Cool White	Neutral White	Warm White	Pasta & Cheese	Bread & Pastries	Meat & Deli
CCT	5000K	4000K	3000K	2700K	2400K	special colour

### LIFETIME

50.000h (L70 B10)

### THERMAL BEHAVIOUR

Operating temperature (operation, no defects)	ta	-30 ... +30 °C
Storage temperature	ts	-30 ... +60 °C
Temperature cooling profile <sup>12</sup>	tc	-30 ... +60 °C

<sup>1</sup> Values apply to operation at 100% output, natural convection.

<sup>2</sup> If the maximum temperature limits are exceeded, the lifetime of the module will be greatly reduced or the module may be destroyed. The tc point temperature at the profile of the light engine should be measured in the thermally stable state and under operating conditions by means of a temperature sensor or temperature-sensitive sticker (available for example from conrad.com or rs-components.com) in accordance with EN60598-1. The entire profile can be used as the tc point.

### STANDARDS

- EN 60598-1
- EN 60598-2-1
- EN 62031
- EN 62471
- EN 60335-2-89 ANNEX BB



#### Note

- Installation should only be conducted by a licensed electrician.
- Reversing the polarity can damage the product!
- Make sure the converter has been switched off prior to connecting the light engine. If this is not observed, the light engine may be damaged!
- Connection or operation is only permitted when using the specified converters. Higher voltages result in damage to or failure of the light engine.
- The user is responsible for correct selection of illumination intensity. Excessive illumination intensity may lead to greying or colour changes of displayed products.