



SHELF | Bright Line



Refrigeration equipment



Shelf lighting



High efficiency



CINCH
Cinch-Connection-System



Dimmable

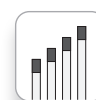

Various lengths

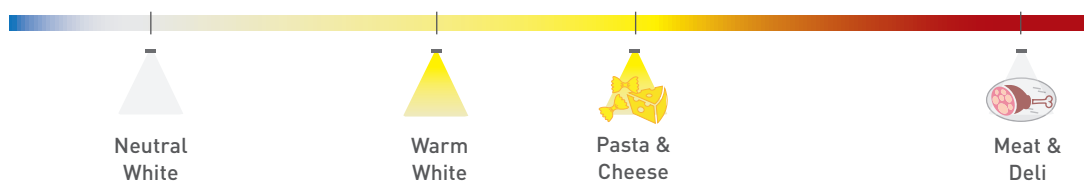

SHELF | Bright Line

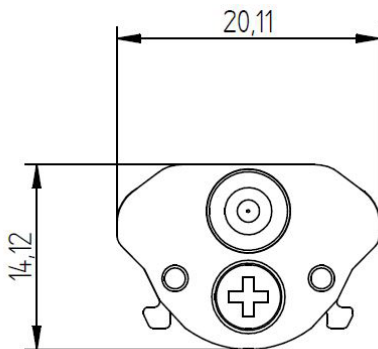

PRODUCT DESCRIPTION

- High efficient shelf lighting for cooling shelves
- Available in a variety of light colours and can be matched to specific food types
- Ready-to-connect solution available, thanks to our Cinch Connection System
- High operational performance due to directional lighting, integrated heat removal and highly efficient LEDs
- Excellent product illumination thanks to the combination of SMD LEDs and innovative optics
- Safe-use operation due safety extra-low voltage (SELV)
- Simple installation with application of fixing plates
- Heat sink profile made of anodised, extruded aluminium
- LED modules protected against moisture & dust by Conformal coating
- End caps made of PBT
- Linear lenses made of PMMA
- Dimming capability

TECHNICAL DATA

Supply voltage	24 VDC
Ambient temperature t_a	-30 ... +30 °C
Max. surface temperature on profile t_c	60 °C
Type of protection	IP44
Protection class	III
Risk group (EN 62471:2008)	1

IP44

ENERGY CLASS

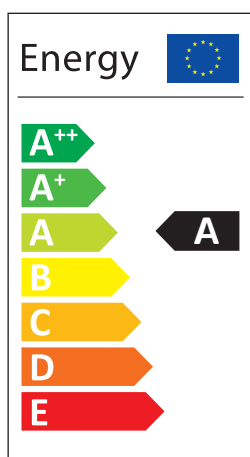

APPLICATION

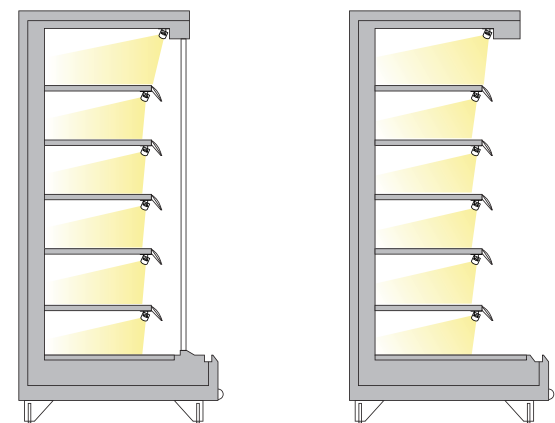

SHELF | Bright Line

TECHNICAL DATA | ORDER DATA

Art. Nr.	Type	Colour	No. of modules	Luminous flux (lm)	Power (W)	CRI
91420148	Bright-Line Shelf 910mm, 4000K CRI90, 6W, CFF8DY	Neutral White	6	710	6,0	≥90
91420149	Bright-Line Shelf 910mm, 3000K CRI90, 6W, CFF8DY	Warm White	6	620	6,0	≥90
91420150	Bright-Line Shelf 910mm, 2700K CRI90, 6W, CFF8DY	Pasta & Cheese	6	590	6,0	≥90
91420151	Bright-Line Shelf 910mm, Meat CRI90, 6W, CFF8DY	Meat & Deli	6	560	6,0	≥90
91420152	Bright-Line Shelf 1200mm, 4000K CRI90, 8W, CFF8DY	Neutral White	8	940	8,0	≥90
91420153	Bright-Line Shelf 1200mm, 3000K CRI90, 8W, CFF8DY	Warm White	8	830	8,0	≥90
91420154	Bright-Line Shelf 1200mm, 2700K CRI90, 8W, CFF8DY	Pasta & Cheese	8	780	8,0	≥90
91420155	Bright-Line Shelf 1200mm, Meat CRI90, 8W, CFF8DY	Meat & Deli	8	740	8,0	≥90

Packaging: 12 pieces/carton, 360 pieces/pallet

- All typical values for Ta=25°C +/- 2°C, setting time =200ms
- Luminous flux min. value = typ. value - 20%
- Tolerance mechanical dimensions +/- 1mm
- Tolerance electrical data +/- 15%
- Tolerance optical data +/-10%

CONVERTER

Output voltage	24VDC +10 %
Power converter	= sum of the typical individual power of the light engines + 20%
Chain length (luminaires)	120mA: max 21 modules 100mA: max 24 modules 80mA: max 28 modules 60mA: max 33 modules 40mA: max 40 modules

Selection of the operating device/protective functions

The operating device protects the modules against overvoltage, overcurrent, overload and short circuits. The device must comply with the relevant standards for safe operation in freezer and refrigeration equipment. Power supply units must ensure the following protective measures:

- SELV
- Short-circuit protection
- Overload protection
- Overtemperature protection
- Protection against environmental influences

ACCESSORY - MOUNT | FIXING PLATES

Type	Shelf Holders - left and right part
Art. Nr.	88167377



Type	METAL 0°	METAL 0° magnetic	METAL 30°	METAL 45°	METAL adjustable	METAL adjustable magnetic
Art. Nr.	88167376	88167382	88167378	88167379	88167384	88167385

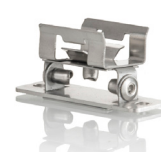
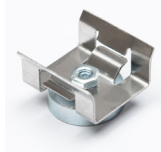

SHELF | Bright Line

■■■ CINCH | FEEDER



- Feeder cable for connecting a linear LED engine to a converter via Cinch

■■■ ORDERING DATA – Feeder

Length	Weight	Type	Art. Nr.
3.000mm	85g	LED Feeder straight CINCH 3000	89601602
4.000mm	102g	LED Feeder angled CINCH 4000	89601603

RoHS

■■■ CINCH | BRIDGE



- Bridge for connecting two linear LED engines via Cinch

■■■ ORDERING DATA – Bridge

Length	Weight	Type	Art. Nr.
120 mm	6g	LED Bridge straight CINCH 120	89601604

RoHS

■■■ CINCH | DIRECT CONNECTOR



- Direct Connection of two linear LED engines via Cinch

■■■ ORDERING DATA – Direct Connector

Length	Weight	Type	Art. Nr.
4,5mm	80g	LED Bridge CINCH direct connector (100 pcs per pack)	89601606

RoHS

■■■ CINCH | PROTECTION PLUG



- Protection Plug for Cinch Endcaps on LED-Luminaires

■■■ ORDERING DATA – Protection Plug

Type	Art. Nr.
LED PROTECTION PLUG CINCH black (100 pcs per pack)	88167416

RoHS

■■■ CINCH | SEALING RING



- Additional sealing ring for connectors at Feeder, Bridge & Direct Connector

■■■ BESTELLDATEN – End Cap

Type	Art. Nr.
LED SEALING RING CINCH black (100 pcs per pack)	88167417

RoHS

SHELF | Bright Line

COORDINATES AND TOLERANCES ACCORDING TO CIE 1964 - DATA REFERS ONLY TO LED MODULES WITHOUT COVER

Neutral White



CIE coordinates
Neutral White 3950K

	x0	y0
Centre	0.3770	0.3660
MacAdam Ellipse: 3SDCM		

Suitable, e.g., for dairy products and frozen products

Pasta & Cheese

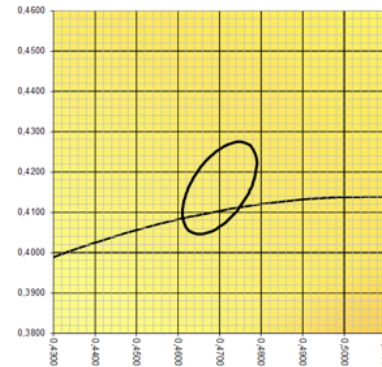

CIE coordinates
Pasta & Cheese 2660K

	x0	y0
Centre	0.4750	0.4160
MacAdam Ellipse: 3SDCM		

Special colour for pasta & cheese

Warm White



CIE coordinates
Warm White 2800K

	x0	y0
Centre	0.4480	0.3990
MacAdam Ellipse: 3SDCM		

Suitable, e.g., for vegetables, fruit and wine

Meat & Deli

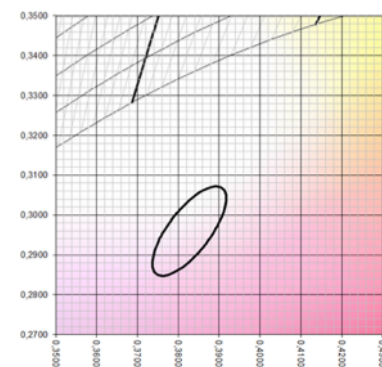

CIE coordinates
Meat & Deli

	x0	y0
Centre	0.3830	0.3060
MacAdam Ellipse: 3SDCM		

Special colour for meat and deli

COLOUR KEY

Code	CW	NW	WW	PC	BP	PM
Colour	Cool White	Neutral White	Warm White	Pasta & Cheese	Bread & Pastries	Meat & Deli
CCT	5000K	4000K	3000K	2700K	2400K	special colour

LIFETIME

50.000h (L70 B10)

STANDARDS

- EN 60598-1
- EN 60598-2-1
- EN 62031
- EN 62471
- EN 60335-2-89 ANNEX BB

THERMAL BEHAVIOUR

Operating temperature (operation, no defects)	ta	-30 ... +30 °C
Storage temperature	ts	-30 ... +60 °C
Temperature cooling profile ¹²	tc	-30 ... +60 °C

¹ Values apply to operation at 100% output, natural convection.

² If the maximum temperature limits are exceeded, the lifetime of the module will be greatly reduced or the module may be destroyed. The tc point temperature at the profile of the light engine should be measured in the thermally stable state and under operating conditions by means of a temperature sensor or temperature-sensitive sticker [available for example from conrad.com or rs-components.com] in accordance with EN60598-1. The entire profile can be used as the tc point.



Note

- Installation should only be conducted by a licensed electrician.
- Reversing the polarity can damage the product!
- Make sure the converter has been switched off prior to connecting the light engine. If this is not observed, the light engine may be damaged!
- Connection or operation is only permitted when using the specified converters. Higher voltages result in damage to or failure of the light engine.
- The user is responsible for correct selection of illumination intensity. Excessive illumination intensity may lead to greying or colour changes of displayed products.